

Schöck Isokorb® T type W

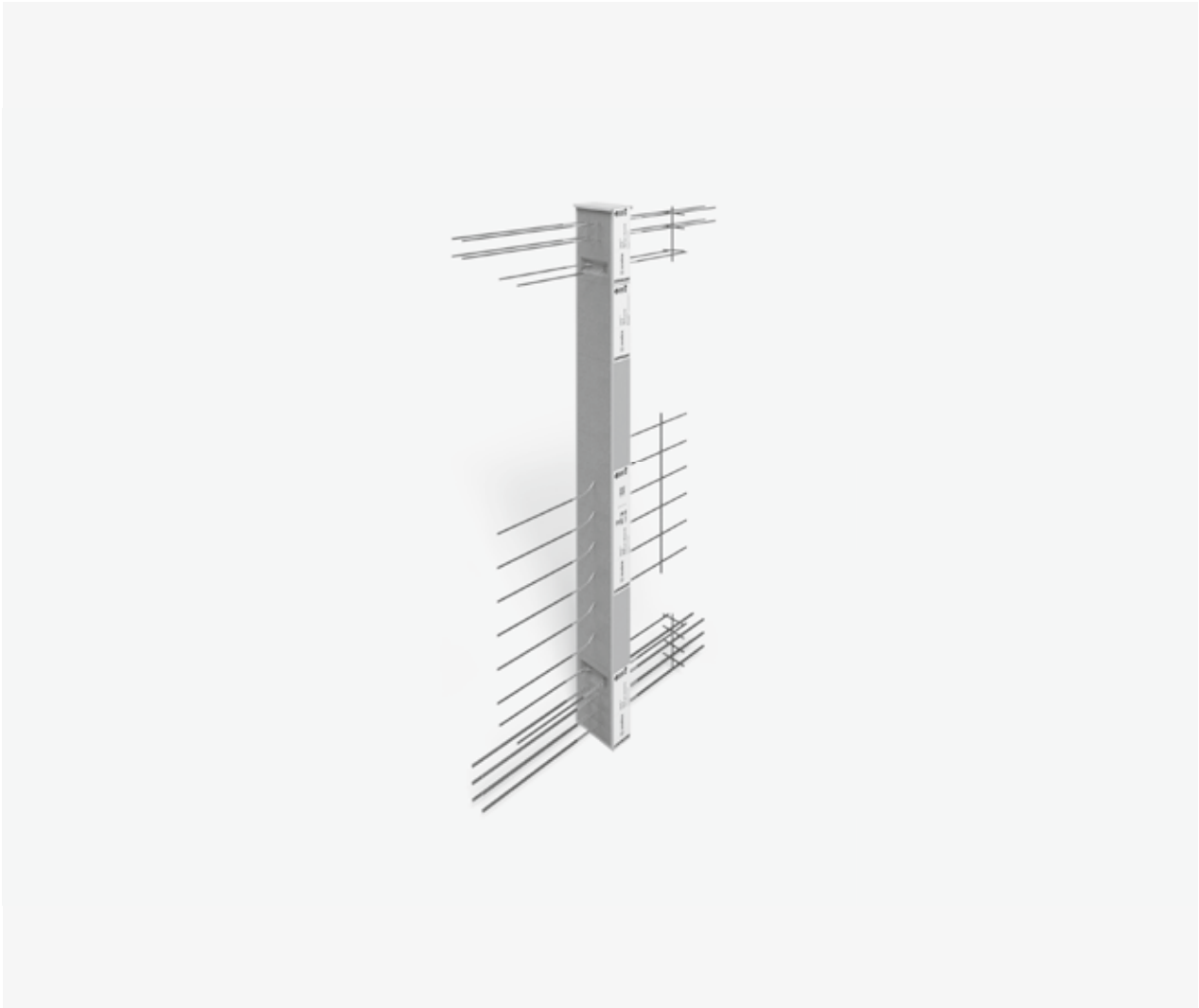

Schöck Isokorb® T type W

Load-bearing thermal insulation element for cross walls. The element transfers negative moments and shear forces.

T
type W

Reinforced concrete – reinforced concrete

Element arrangement | Installation cross section

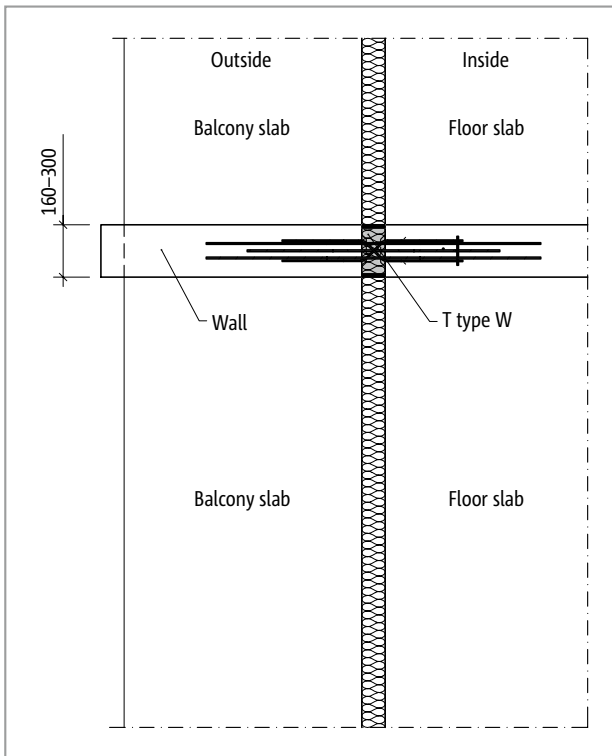

Fig. 267: Schöck Isokorb® T type W: Layout; Balcony structure with thermally insulated load-bearing shear walls

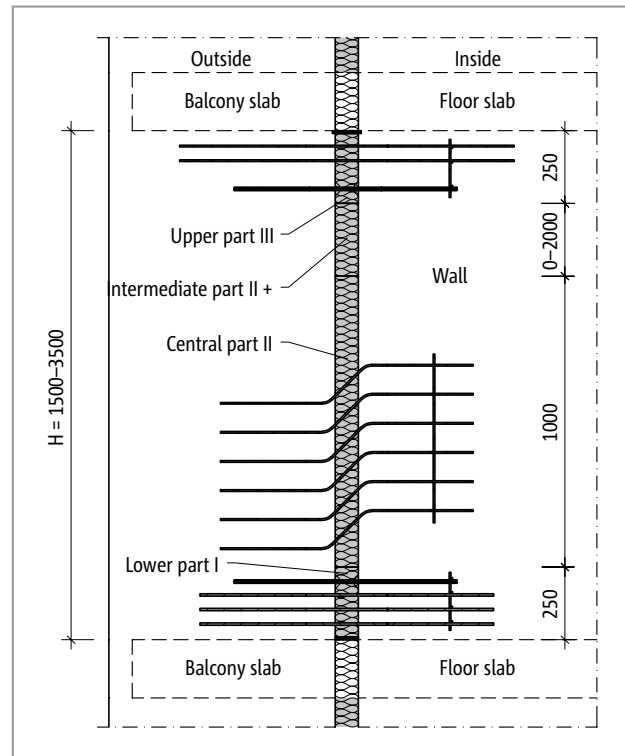

Fig. 268: Schöck Isokorb® T type W: Balcony structure with thermal insulated load-bearing shear walls

i Element arrangement

- The Schöck Isokorb® T type W consists of at least 3 parts: Bottom section I, middle section II, top section III. Depending on height an insulation spacer II+ is additionally required.

Product selection | Type designations | Special designs

Schöck Isokorb® T type W variants

The configuration of the Schöck Isokorb® T type W can be varied as follows:

- Main load-bearing level: M1 to M4
- Secondary load capacity: V1
- Fire resistance class:
R90 (standard): Top fire protection board, projecting on both sides by both 10 mm
- Insulation element thickness:
X80 = 80 mm
- Isokorb® height:
H = 1500 mm to 3500 mm
- Isokorb® length:
L = 160 mm to 300 mm for R90
- Part designation (optional): Upper part, central part, lower part
- Generation:
5.0

i Variants

- Please specify the required dimensions when ordering.

Type designations in planning documents

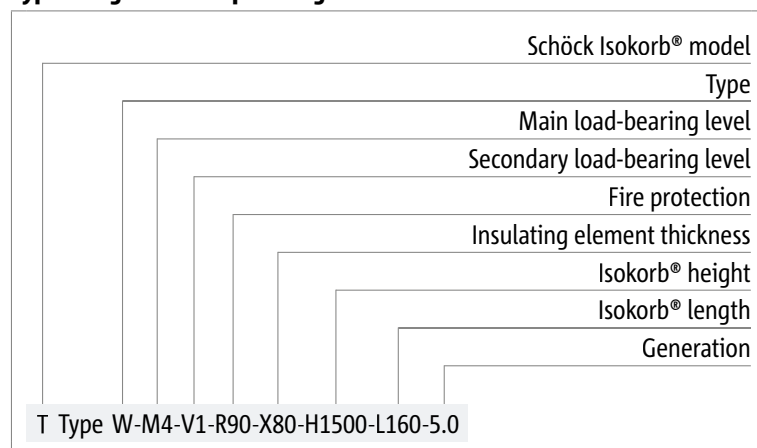

i Special designs

Please contact the design support department if you have connections that are not possible with the standard product variants shown in this information (contact details on page 3).

C25/30 design

Schöck Isokorb® T type W		M1	M2	M3	M4
Design values with		Concrete strength class \geq C25/30			
		$M_{Rd,y}$ [kNm/element]			
	1500-1990	-64.8	-115.0	-179.5	-146.7
	2000-2490	-89.4	-158.8	-247.8	-202.5
	2500-3500	-114.0	-202.5	-316.1	-258.4
Isokorb® height H [mm]	$V_{Rd,z}$ [kN/element]				
	1500-3500	52.2	92.7	144.9	208.6
	$V_{Rd,y}$ [kN/element]				
	1500-3500	± 17.4	± 17.4	± 17.4	± 17.4

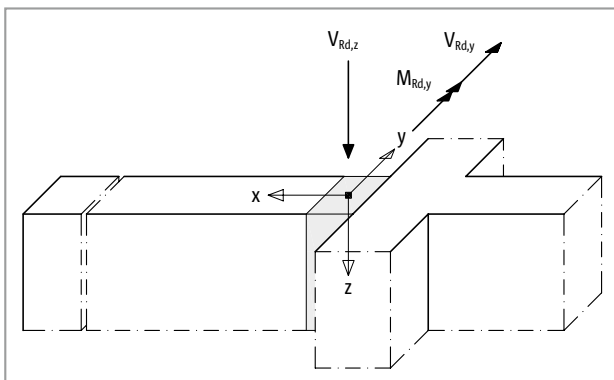

Fig. 269: Schöck Isokorb® T type W: Sign rule for the design

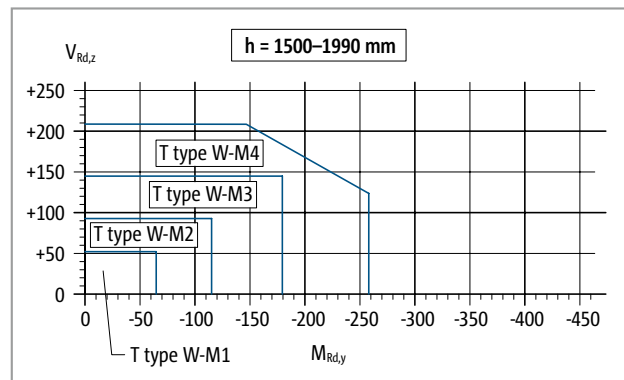

Fig. 270: Schöck Isokorb® T type W: Interaction diagram

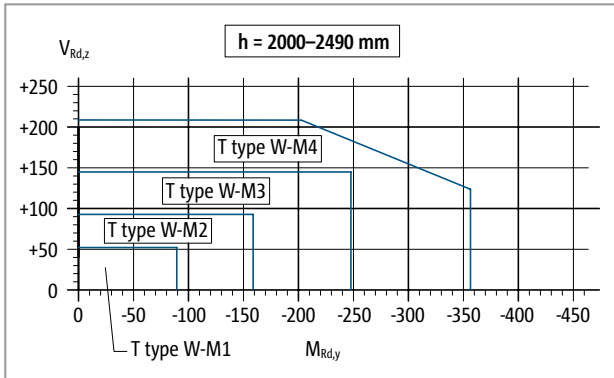

Fig. 271: Schöck Isokorb® T type W: Interaction diagram

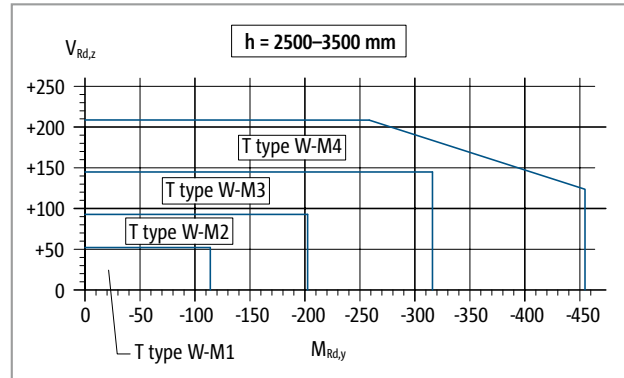

Fig. 272: Schöck Isokorb® T type W: Interaction diagram

T
type W

Design | Expansion joint spacing

Schöck Isokorb® T type W	M1	M2	M3	M4
Placement with	Isokorb® length [mm]			
	150-300	150-300	150-300	150-300
Tension bars	4 \varnothing 6	4 \varnothing 8	4 \varnothing 10	4 \varnothing 12
Compression bars	6 \varnothing 8	6 \varnothing 10	6 \varnothing 12	6 \varnothing 14
Shear force bars vertical	6 \varnothing 6	6 \varnothing 8	6 \varnothing 10	6 \varnothing 12
Shear force bars horizontal	2 \times 2 \varnothing 6	2 \times 2 \varnothing 6	2 \times 2 \varnothing 6	2 \times 2 \varnothing 6
L_{\min} for R0 [mm]	150	150	150	150
L_{\min} for R90 [mm]	160	160	160	160 </td

Notes on design

- Wind force moments are to be absorbed by the stiffening effect of the balcony slabs. If this is not possible, $M_{Ed,z}$ can be transferred by the additional layout of a Schöck Isokorb® T type D. The T type D in this case is installed in a vertical position in place of the insulating adapter.
- Poor bonding conditions (bonding range II) are the basis for the determination of the tension bar anchoring lengths.
- The indicative minimum concrete strength class of the external structural component is C32/40.

Maximum expansion joint spacing

If the structural component length exceeds the maximum expansion joint spacing e , expansion joints must be installed in the exterior concrete structural components at right angles to the insulation plane, in order to limit the effect as a result of temperature changes.

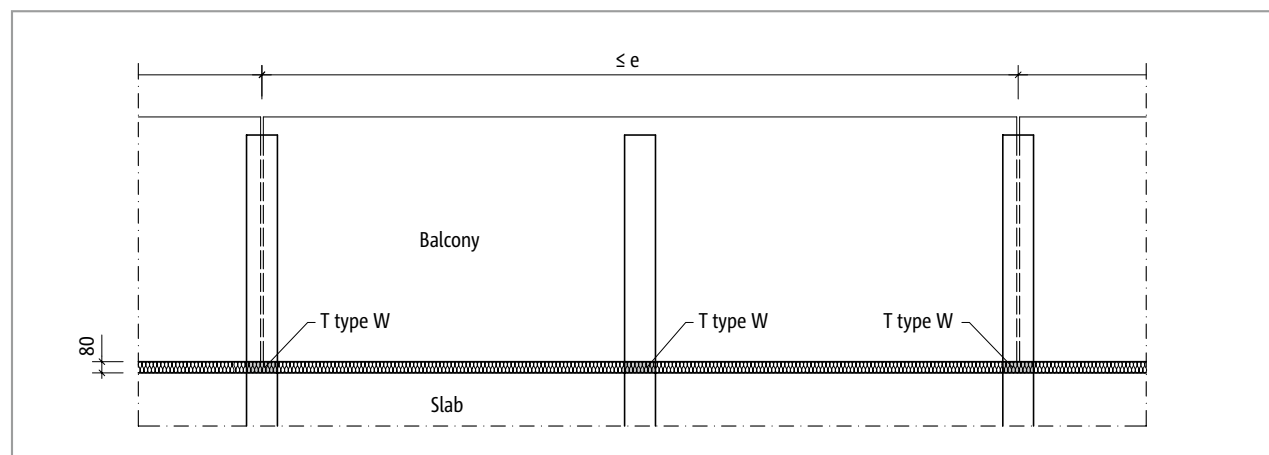

Fig. 273: Schöck Isokorb® T type W: Expansion joint layout

Schöck Isokorb® T type W	M1	M2	M3	M4	
Maximum expansion joint spacing when	e [m]				
Insulating element thickness [mm]	80	13.5	13.0	11.7	10.1

Expansion joints

- The expansion joint spacings can be enlarged, if there is no fixed connection between balcony slabs and shear walls, e. g. through laying of a sliding foil.

Product description

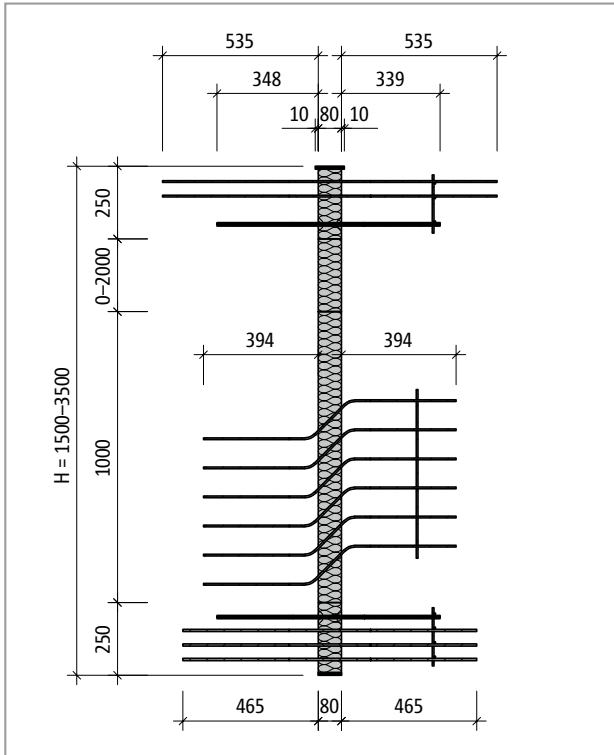

Fig. 274: Schöck Isokorb® T type W-M1-R90: Product layout; Fire protection board top and bottom

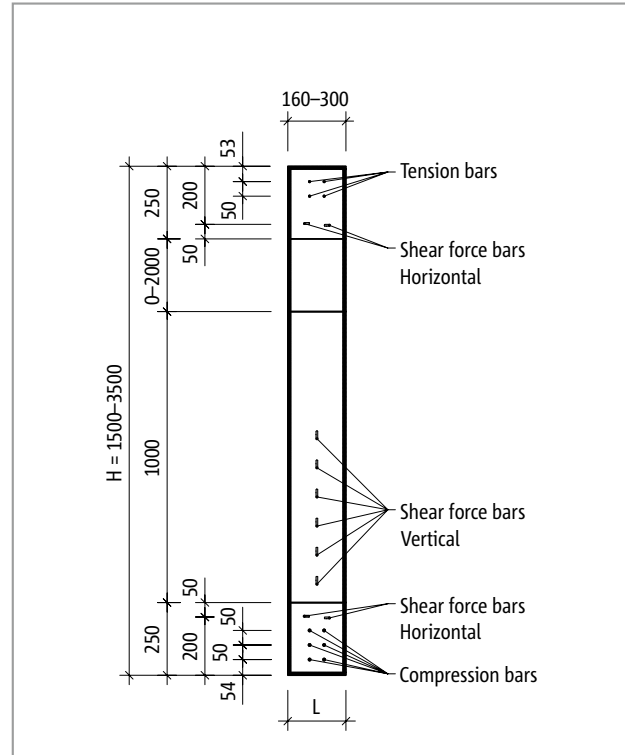

Fig. 275: Schöck Isokorb® T type W-M1-R90: Product layout; perimeter fire protection boards

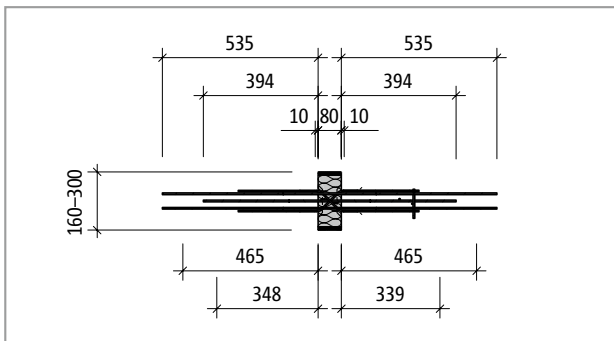

Fig. 276: Schöck Isokorb® T type W-M1: Product layout

Product information

- Download further product plan views and cross-sections at www.schoeck.com/en-gb/download

On-site reinforcement

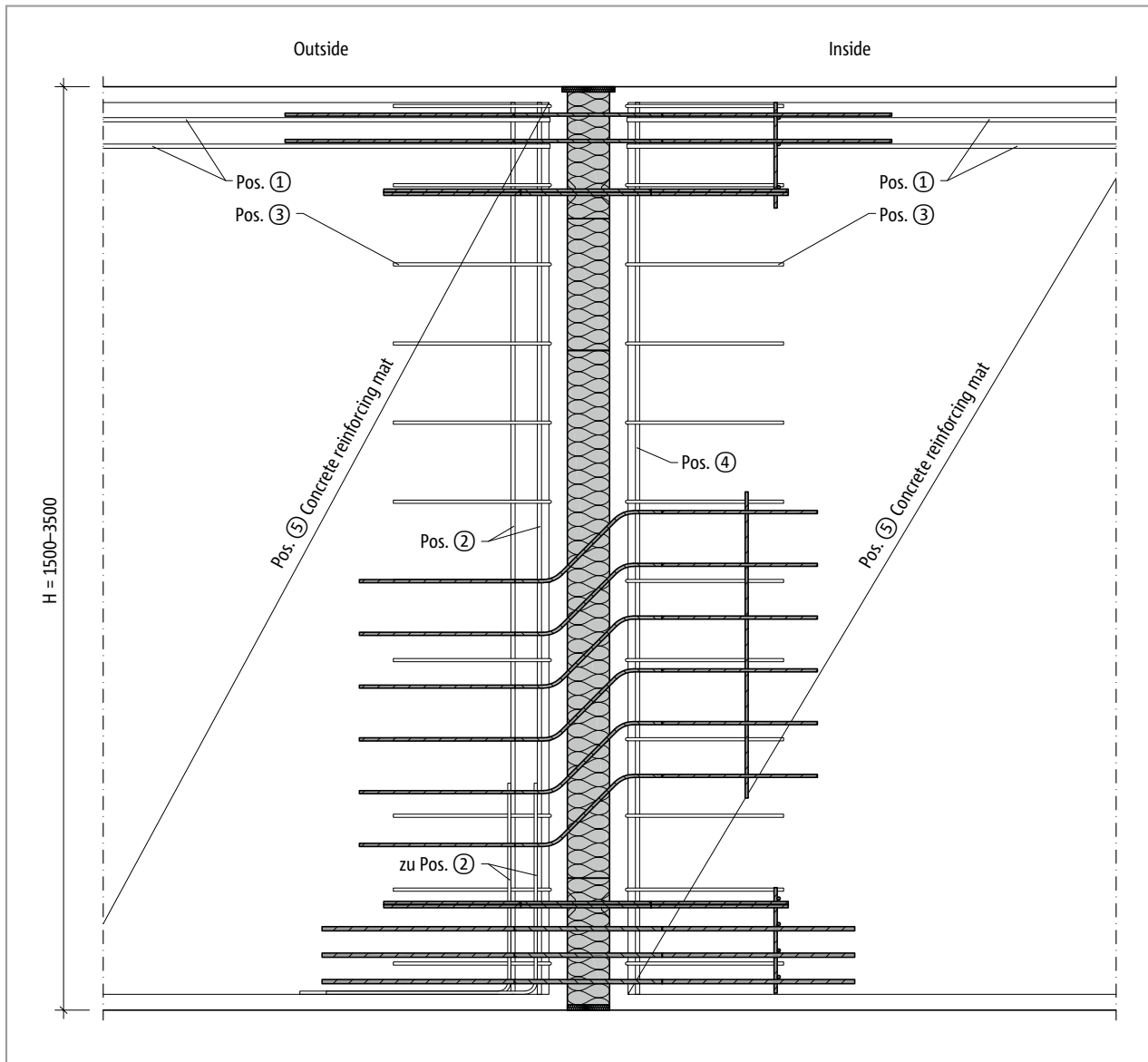

Fig. 277: Schöck Isokorb® T type W: On-site reinforcement (cross-section)

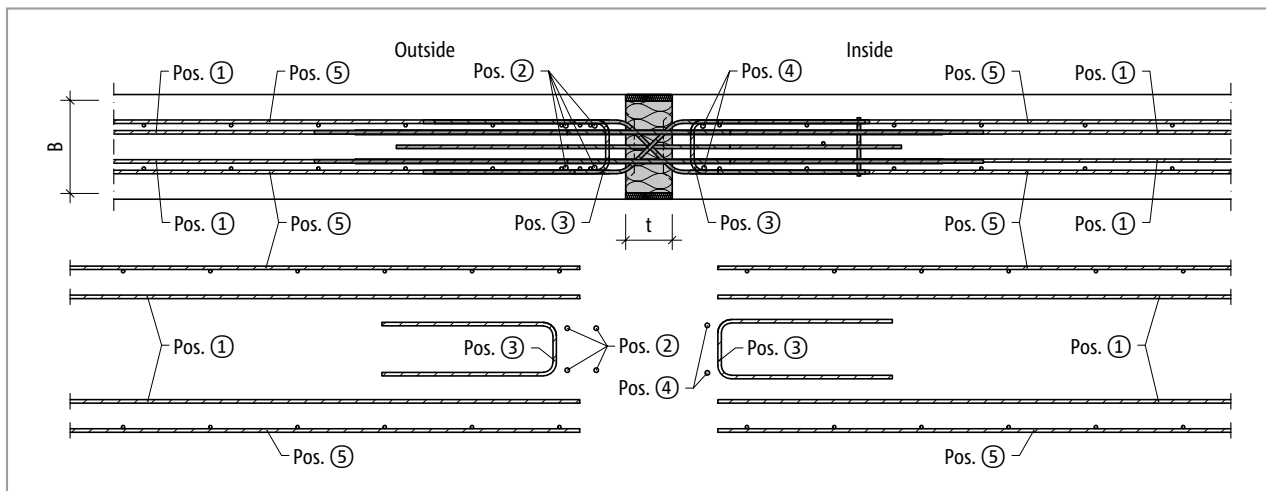

Fig. 278: Schöck Isokorb® T type W: On-site reinforcement (layout)

T
type W

Reinforced concrete – reinforced concrete

On-site reinforcement | Installation | Installation instructions

Recommendation for the on-site connection reinforcement

Details of the lapping reinforcement for Schöck Isokorb® with a loading of 100 % of the maximum design moment with C25/30; positively selected: a_s lapping reinforcement $\geq a_s$ Isokorb® tension bars/compression members.

Schöck Isokorb® T type W	M1	M2	M3	M4
On-site reinforcement	Concrete strength class \geq C25/30			
Overlapping reinforcement				
Pos. 1	4 · H8	4 · H8	4 · H10	4 · H12
Lap length l_0 [mm]	481	641	801	961
Suspension reinforcement (anchorage using stirrup or L)				
Pos. 2	2 · 2 · H8	2 · 2 · H10	2 · 2 · H12	2 · 2 · H16
Supplementary edge reinforcement				
Pos. 3 and 4	acc. to the specifications of the structural engineer			
Wall reinforcement and overlap reinforcement shear force bar				
Pos. 5	acc. to the specifications of the structural engineer			

i Information about on-site reinforcement

- Alternative connection reinforcements are possible. The rules as per BS EN 1992-1-1 (EC2) and BS EN 1992-1-1/NA apply for the determination of the lap length. A reduction of the required lap length with m_{Ed}/m_{Rd} is permitted.
- The indicative minimum concrete strength class of the external structural component is C32/40.

i Installation

The Schöck Isokorb® T type W is delivered in various components (bottom section, middle section, intermediate section, upper section).

- Depending on the quantity ordered, similar components will be on one pallet for purposes of transport safety.
- The arrangement of components takes place on the building site in accordance with installation instructions.

i Installation instructions

The current installation instruction can be found online under:
www.schoeck.com/view/6431

✓ Check list

- Have the loads on the Schöck Isokorb® connection been specified at design level?
- Has the cantilevered system length or the system support width been taken as a basis?
- With the selection of the design table is the relevant concrete strength class taken into account?
- With the selection of the design table is the relevant concrete cover taken into account?
- Are the maximum allowable expansion joint spacings taken into account?
- Are the requirements with regard to fire protection clarified and is the appropriate supplement entered in the Isokorb® type designation and in the implementation plans?
- Have the requirements for on-site reinforcement of connections been defined in each case?

